

LED line PRIME

Code: 220447

EAN: 5905378220447

**Connector for LED strips Fast Connector
3gen. straight SMD/COB 2pin 10mm 6A
PCB-PCB PRIME (10 pcs.)**

Easy and quick installation of LED strips without the use of tools – 3rd generation connectors allow for instant and safe connections, saving time and installation costs.

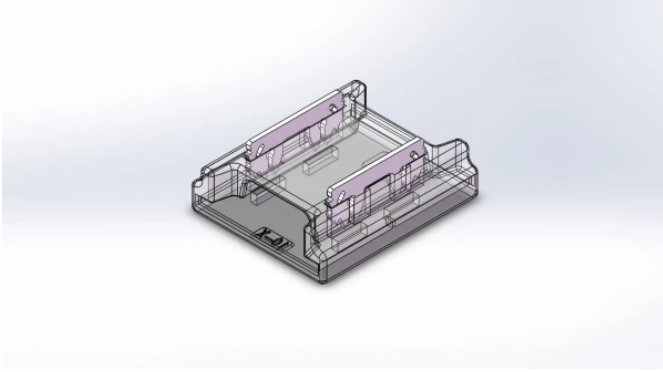

Technical data

Parameter	Value
Warranty	5
Voltage	• 12-24 V DC
IP protection rating	IP20
Connector type	I

Parameter	Value
Maximum width of LED strip	10 mm
LED type	SMD/COB
For indoor use	Inside

LED line PRIME

Code: 220447

EAN: 5905378220447

**Connector for LED strips Fast Connector
3gen. straight SMD/COB 2pin 10mm 6A
PCB-PCB PRIME (10 pcs.)**

Technical drawing

Light distribution

Additional product photos

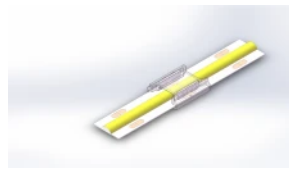
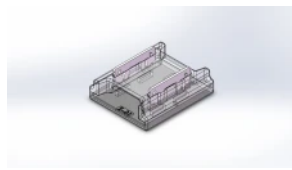
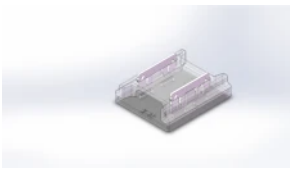

Logistics data

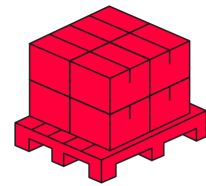
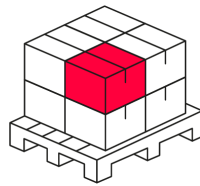
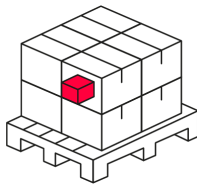

Single packaging

Quantity	10
Width	10,5 cm
Height	2 cm
Length	15 cm
Weight	0,38 kg

Bulk packaging

Quantity	3000
Width	36 cm
Height	43 cm
Length	25 cm
Weight	8,6 kg

Europallet

LED line PRIME

Code: 220447

EAN: 5905378220447

**Connector for LED strips Fast Connector
3gen. straight SMD/COB 2pin 10mm 6A
PCB-PCB PRIME (10 pcs.)**

Example application