

LED line PRIME

Symbol: 220447

EAN: 5905378220447

Fast Connector 3gen. eenvoudige SMD/COB 2pin 10mm 6A PCB-PCB PRIME (10 st.)

Gemakkelijke en snelle installatie van LED-strips zonder gereedschap – 3e generatie connectors maken snelle en veilige verbindingen mogelijk, waardoor tijd en installatiekosten worden bespaard.

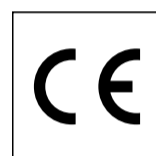
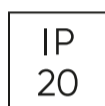
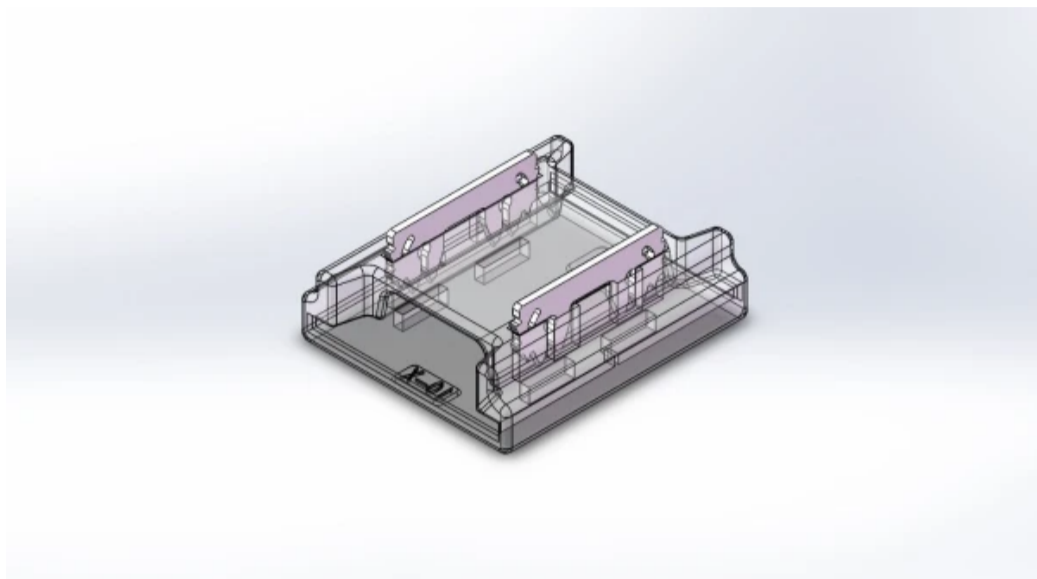

Technische gegevens

Parameter	Waarde
Garantie	5
Spanning	• 12-24 V DC
Dichtheidsklasse	IP20
Connectortype	I
Maximale breedte van de LED-strip	10 mm

Parameter	Waarde
Diodetype	SMD/COB
Voor toepassingen	Binnen in de kamers
Lengte	13,5 mm
Breedte	11,5 mm
Weegschaal	0,038 kg

LED line PRIME

Symbol: 220447

EAN: 5905378220447

Fast Connector 3gen. eenvoudige SMD/COB 2pin 10mm 6A PCB-PCB PRIME (10 st.)

Technisch tekenen

Lichtverdeling

Extra productfoto's

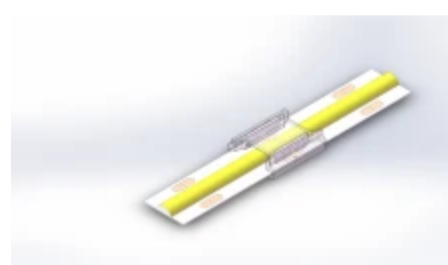
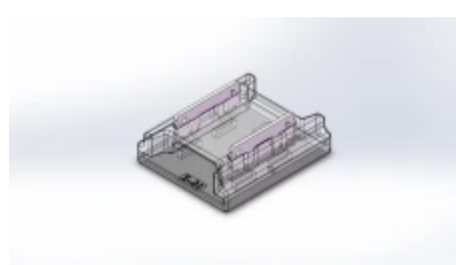
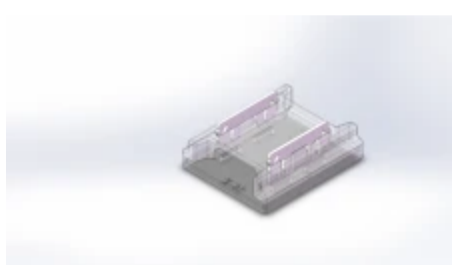

Logistieke gegevens

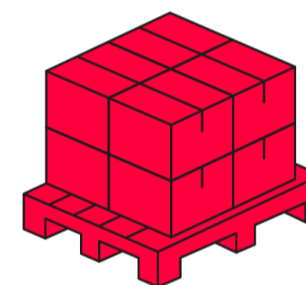
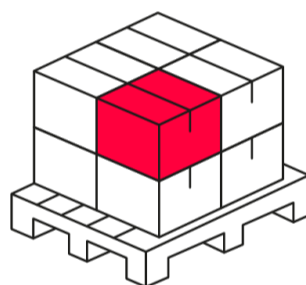
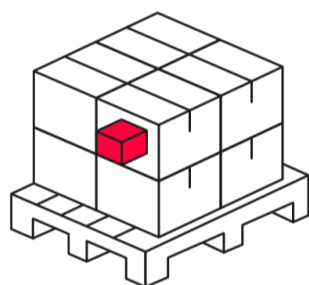

Individuele verpakking

Hoeveelheid	10
Breedte	10,5 cm
Hoogte	2 cm
Lengte	15 cm
Weegschaal	0,38 kg

Bulkverpakkingen

Hoeveelheid	3000
Breedte	36 cm
Hoogte	43 cm
Lengte	25 cm
Weegschaal	8,6 kg

Europallet

LED line PRIME

Symbol: 220447

EAN: 5905378220447

**Fast Connector 3gen. eenvoudige
SMD/COB 2pin 10mm 6A PCB-PCB
PRIME (10 st.)**

Voorbeeldimplementatie