

12 configurations in one panel

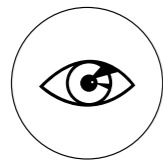

UGR < 19

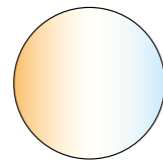

3CCT light color adjustment

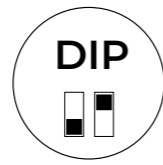

DIP switch power changes



Built-in high-end power supply

LED PANEL BACKLIT 3CCT UGR<19

Key features

- ▶ Luminous efficacy up to 120 lm/W
- ▶ Multi-Power + 3CCT – one fixture, four wattages and three light colors
- ▶ 12 configurations in a single panel
- ▶ Low glare UGR <19 for visual comfort
- ▶ Backlit technology for uniform light distribution
- ▶ Available in 60x60 and 120x30 formats
- ▶ External power supply with easy parameter selection
- ▶ 5-year warranty

EFFICACY
120 lm/W

Power [W]:
28-32-36-40

Luminous flux [lm]:
4800 (max.)

Beam angle [°]
90

Colour temperature [K]:
CCT 3000-4000-6000



Lifetime [h]:
L70B50 - 50.000

Diffuser:
polistyren

Housing:
metal

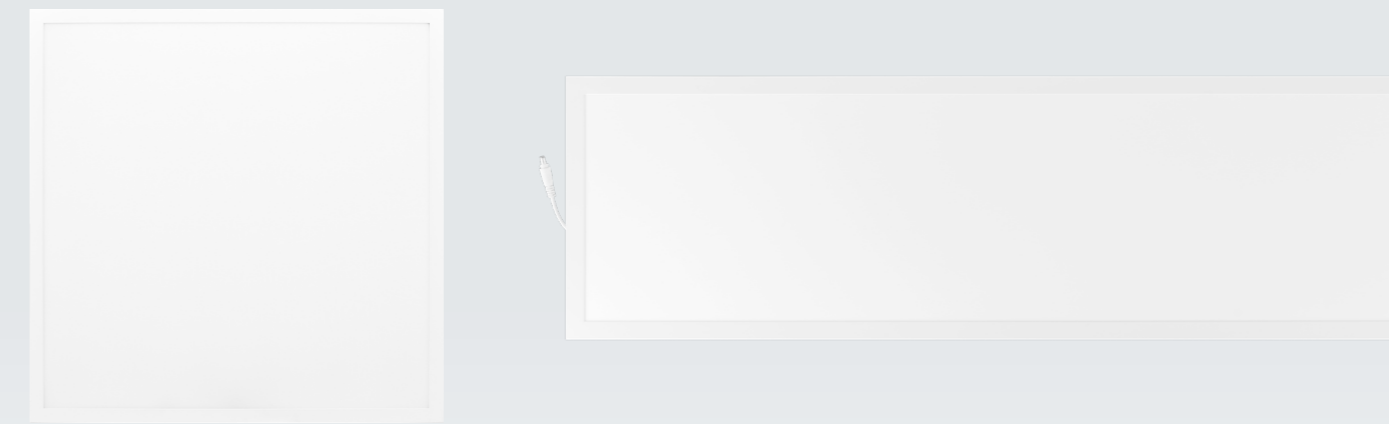

DESIGNED FOR FLEXIBLE PROJECTS

Modern projects require flexibility. Assumptions, budgets, space layouts, and investor expectations are constantly changing. This panel has been designed with this reality in mind.

Multi-Power and 3CCT offer a total of 12 configurations in a single luminaire. Four power levels and three light colors allow you to tailor the parameters precisely to the function of the space, without changing the model, without complicating the order, and without the risk of running out of “the right version” during installation.

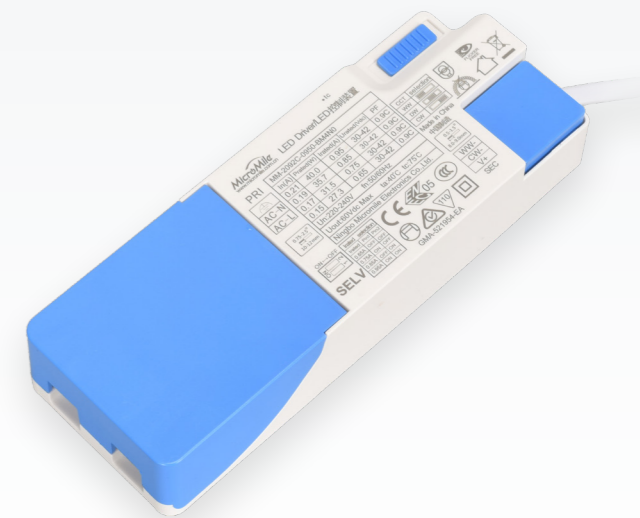

12IN1 - POWER SUPPLY

An external power supply with clearly marked power and light color switches allows for quick parameter setting without dismantling the luminaire and without additional tools.

Configuration takes place directly at the installation site, which reduces installation time and eliminates the risk of selecting the wrong version before ordering. For distributors, this means real savings of up to 11 separate stock codes. One product replaces many variants, simplifies logistics, and reduces tied-up capital.

28W

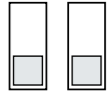

32W

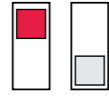

36W

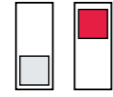

40W

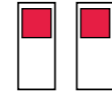

3000K

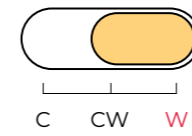

4000K

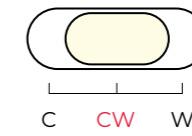

6000K

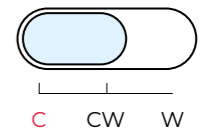

FULL PARAMETER CONTROL

Four power levels and three color temperatures allow you to precisely match the panel to the space and the required illumination level.

From energy-saving 28W settings up to powerful 40W, and from warm 3000K to cool 6000K, the parameters can be adapted to the room's function without changing the fixture.

One platform. Full control of light.

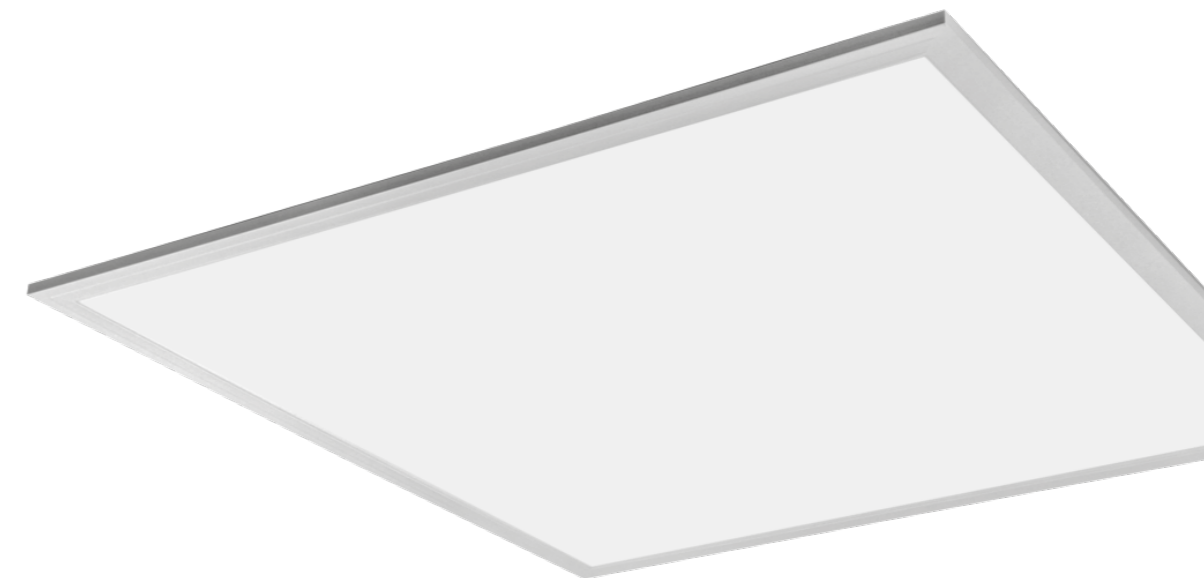



COMFORT BY DESIGN - UGR<19

A low glare rating of UGR <19 ensures the panel meets the requirements of modern office spaces and public buildings. The light remains uniform and comfortable even during long periods of visual work.

This parameter has a real impact on user well-being, reducing eye fatigue and supporting concentration

The design meets the standards, and the user experiences a noticeable improvement in comfort.

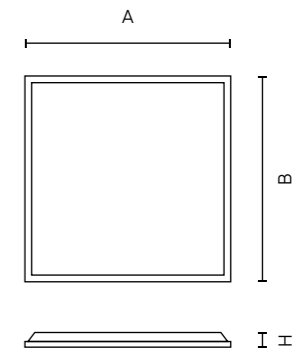
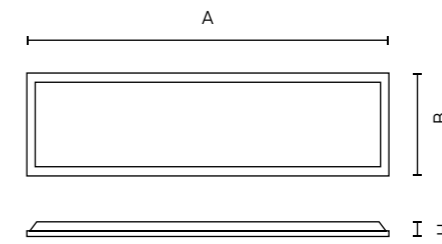
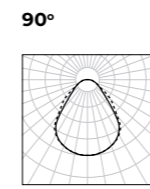

LED Panel BACKLIT 3CCT MultiPower UGR<19 60x60 PRIME

SYMBOL	[W]	☞ [°]	● [K]	☀ [lm]	AxBxH [mm]	EEI
222950	28-32-36-40	90	3000-4000-6000 (CCT)	4800	595 x 595 x 32	A G E

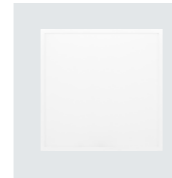

LED Panel BACKLIT 3CCT MultiPower UGR<19 120x30 PRIME

SYMBOL	[W]	☞ [°]	● [K]	☀ [lm]	AxBxH [mm]	EEI
223967	28-32-36-40	90	3000-4000-6000 (CCT)	4800	1195 x 295 x 32	A G E



Surface mounting frames LITE

209756-II 600 x 600 x 62

204546 1200 x 300 x 62



Surface mounting frames PRIME

209763 600 x 600 x 70

209770 1200 x 300 x 70

LED line

WE CO-CREATE

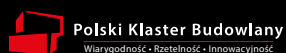

LEDIN Group Sp. z o.o.
Dębowa 1
07-410 Tobolice
Poland

export@ledline.pl
ledline.eu

 /LEDIN Group Sp. z o.o.

 /LED line

 /LED line